

Pos.-Nr. Pos.no. Position	Beschreibung Description Désignation	Art.-Nr. Art.no. Ref.	Preisgruppe Price bracket Catégorie de prix
73190	SNCF X2800		
73191			
1	Kardanschale kurz 1,5mm Cardan reception short 1,5mm Cousinnet à cardan courtes 1,5mm	87129	4
2	Führerstand Driver's cab Cabine de conduite	95298	6
3	Brückenstecker Connector Fiche de shuntage	129630	10
4	Kardanwelle Cardan shaft Arbre à cardan	107011	4
5	Drahtlampe T3/4 16V 30mA Bulb with leads T3/4 16V 30mA Ampoule T3/4 16V 30mA	108616	8
6	Drahtlampe rot T3/4 16V Bulb with leads red T3/4 16V Ampoule T3/4 16V rouge	110479	8
7	GF-Schraube M2x6 mm Self-tapping screw M2x6 mm Vis auto- taraudeuse M2x6 mm	114828	3
8	GF-Schraube M2x8 mm Self-tapping screw M2x8 mm Vis auto- taraudeuse M2x8 mm	114923	3
9	GF-Schraube M2x5 mm Self-tapping screw M2x5 mm Vis auto- taraudeuse M2x5 mm	114966	3
10	GF-Schraube M1,6x5 mm Self-tapping screw M1,6x5 mm Vis auto- taraudeuse M1,6x5 mm	115269	3
11	Inneneinrichtung Interior fittings Équipement intérieur	139676	6
12	Gewicht Motorseite Weight motor side Ballast au côté moteur	115589	9
13	Gewicht hinten Weight rear Ballast arrière	115590	7
14	Puffer lang Buffer long Tampon longue	115593	3
15	Platine komplett PCB assembly Circuit imprimé	139677	19
16	Innenbeleuchtung kpl. Illumination complete Éclairage intérieur complet	115595	18
17	Motor Motor Moteur	115596	27
18	Vorhangsatz Curtain set Rideau set	115602	6
19	Stirnfenster-Leuchtstabsatz Front window-light conductor set Vitre frontal - Conducteur de lumière	115622	6
20	Puffer eckig kurz Rectangular buffer short Tampon rectangulaire, court	115623	3
21	Fenstersatz Window set Jeu de fenestres	115624	10
22	Bodenplatte Floor plate Plaque de fond	115628	7
23	Gehäuse komplett 2862 Body ass. 2862 Caisse complète n° 2862	139678	30
24	TS - Gehäuse lackiert Part set of body painted Jeu d'accessoires du caisse, laquée	139691	10
Sound 73191			
25	Lautsprecher Loudspeaker Les haut-parleurs	129524	16
26	Führerstand soundbox Driver's cab sound box Cabine de conduite caisse de son	139681	6
27	Sounddecoder Plux 16 Sound-decoder Plux 16 Décodeur Plux 16	129300	39

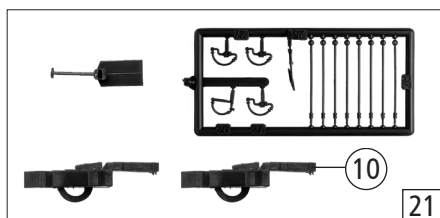
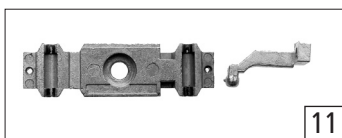
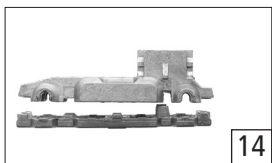
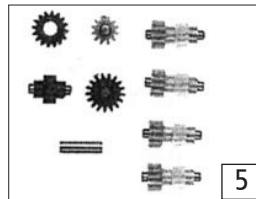
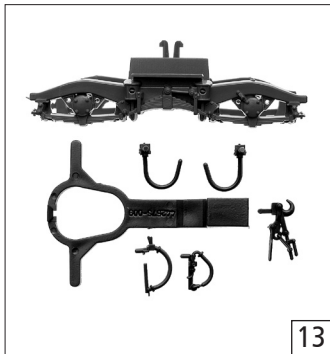
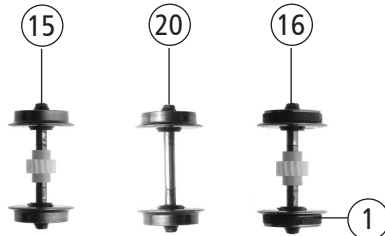
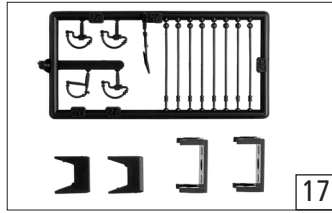
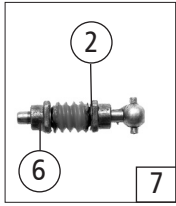

73190		SNCF	X2800	=	
73191				=	🔊
Pos. Nr. Pos.no. Position	Beschreibung Description Désignation	Art.-Nr. Art.no. Ref.	Preisgruppe Price bracket Catégorie de prix		
1	Haftrings.10Stk.8,3-10,2mm Set with traction tyres Bandage d'adhérence	40068	---		
2	Beilagscheibe 2.1x4/0.2 mm Washer 2.1x4/.2 mm Plaque 2.1x4/.2 mm	86108	3		
3	Zugfeder Draw spring Ressort de traction	86208	3		
4	Zahnrad Z=16 rechts Gear Z=16 right Roue dentée Z=16 à droite	86435	3		
5	Getriebe Nachrüstsatz Gear set Jeu d'engrenage complémentaire	86488	17		
6	Lager für Schneckenachse Bearing for worm gear axle Palier de l'axe du vis sans fin	89749	6		
7	Schneckensatz kpl. Set of worm gear complete Jeu de vis sans fin	115597	13		
8	Standardkupplung kpl. Standard coupling Accouplement standard	89246	6		
9	Radkontakt Wheel contact Contact de la roue	95827	3		
10	Kurzkupplung-Vorentkupplung Short coupling- pre-uncoupling Couplage en court	115550	6		
11	Teilesatz 1 f. Getriebe 2-teilig Parts set 1 gear 2-parts Jeu d'engrenages (2 pièces)	115591	11		
12	Teileatz Drehgestell und Kupplung Part set bogie and couplings Jeu bogie et accouplements	115592	8		
13	Teilesatz Fahrwerk Part set chassis Accessoires et cadre bogie motorisée	115606	8		
14	Teiles. 2 Getriebe 2-teilig Part set 2 gear 2-parts Jeu d'engrenages (2 pièces)	115609	12		
15	Radsatz ohne Haftring mit Zahnrad Wheelset w/o traction tyre w.gear wheel Essieu sans bandages avec roue dentée	115610	11		
16	Radsatz mit 2 Haftringe,Zahnrad Wheelset with 2 traction tyres w.gear wheel Essieu avec bandages et roue dentée	115611	12		
17	Teilesatz Drehgestell Part set bogie Jeu d'accessoires bogie	115612	5		
18	Blende V Triebwagen Bogie frame V motor car Cadre bogie V pour automotrices	115613	8		
19	Kontaktaltersatz Contact holder set Porte contact set	115614	4		
20	Radsatz ohne Haftring Wheelset without traction tyres Essieu à roues sans bandagé	115615	10		
21	Zurüstbeutel Bag with accessories Sachet de pièces de finition	125893	11		

Ersatzteile erhalten Sie bei Ihrem Fachhändler,
oder Ihrer Landesvertretung:
You can order your Replacement Parts at your local dealer,
your country representative:
Passez commande des pièces détachées chez votre détaillant,
chez le S.A.V. de votre impor-tateur national: